

Dual P-Channel MOSFET

SI1903DL (KI1903DL)

■ Features

- $V_{DS} (V) = -20V$
- $I_D = -4.1 A (V_{GS} = -10V)$
- $R_{DS(ON)} < 0.995 \Omega (V_{GS} = -4.5V)$
- $R_{DS(ON)} < 1.19 \Omega (V_{GS} = -3.6V)$
- $R_{DS(ON)} < 1.8 \Omega (V_{GS} = -2.5V)$

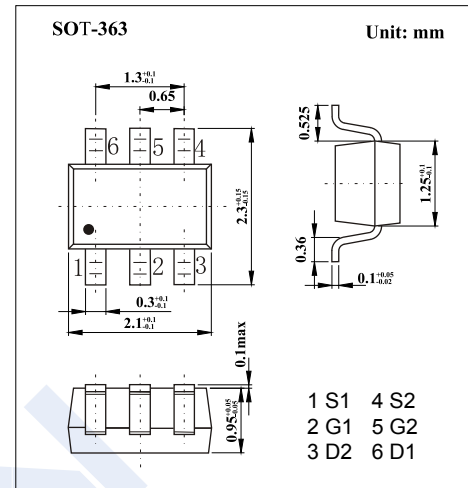
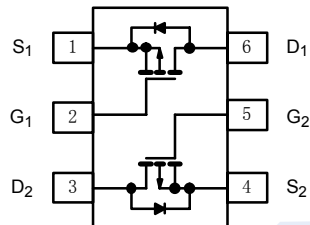

■ Absolute Maximum Ratings $T_a = 25^\circ C$

Parameter	Symbol	5 Secs	Steady State	Unit	
Drain-Source Voltage	V_{DS}	-20		V	
Gate-Source Voltage	V_{GS}	± 12			
Continuous Drain Current	I_D	$T_a = 25^\circ C$	-0.44	-0.41	A
		$T_a = 75^\circ C$	-0.31	-0.3	
Pulsed Drain Current	I_{DM}	-1			
Power Dissipation	P_D	$T_a = 25^\circ C$	0.3	0.27	W
		$T_a = 75^\circ C$	0.16	0.14	
Thermal Resistance.Junction- to-Ambient	R_{thJA}	415	460	$^\circ C/W$	
Thermal Resistance.Junction- to-Foot	R_{thJF}	-	350		
Junction Temperature	T_J	150		$^\circ C$	
Junction Storage Temperature Range	T_{stg}	-55 to 150			

Dual P-Channel MOSFET

SI1903DL (KI1903DL)

■ Electrical Characteristics Ta = 25°C

Parameter	Symbol	Test Conditions	Min	Typ	Max	Unit
Drain-Source Breakdown Voltage	V _{DSS}	I _D =-250 μA, V _{GS} =0V	-20			V
Zero Gate Voltage Drain Current	I _{DSS}	V _{DS} =-20V, V _{GS} =0V			-1	μA
		V _{DS} =-20V, V _{GS} =0V, T _J =85°C			-5	
Gate-Body leakage current	I _{GSS}	V _{DS} =0V, V _{GS} =±12V			±100	nA
Gate Threshold Voltage	V _{GS(th)}	V _{DS} =V _{GS} , I _D =-250 μA	-0.6		-1.5	V
Static Drain-Source On-Resistance	R _{DS(on)}	V _{GS} =-4.5V, I _D =-0.41A			0.995	Ω
		V _{GS} =-3.6V, I _D =-0.38A			1.19	
		V _{GS} =-2.5V, I _D =-0.25A			1.8	
On state drain current	I _{D(ON)}	V _{GS} =-4.5V, V _{DS} =-5V	-1			A
Forward Transconductance	g _{FS}	V _{DS} =-10V, I _D =-0.41A		0.8		S
Total Gate Charge	Q _g	V _{GS} =-4.5V, V _{DS} =-10V, I _D =-0.41A		1.2	1.8	nC
Gate Source Charge	Q _{gs}			0.45		
Gate Drain Charge	Q _{gd}			0.25		
Turn-On DelayTime	t _{d(on)}	V _{DD} = -10V, R _L = 20Ω I _D =-0.5A, V _{GEN} = -4.5V, R _g = 6Ω			15	ns
Turn-On Rise Time	t _r				40	
Turn-Off DelayTime	t _{d(off)}				17	
Turn-Off Fall Time	t _f				24	
Body Diode Reverse Recovery Time	t _{rr}	I _F =-0.23A, di/dt=100A/us			40	
Maximum Body-Diode Continuous Current	I _S				-0.25	A
Diode Forward Voltage	V _{SD}	I _S =-0.23A, V _{GS} =0V			-1.2	V

■ Marking

Marking	QA**
---------	------

Dual P-Channel MOSFET

SI1903DL (KI1903DL)

Typical Characteristics

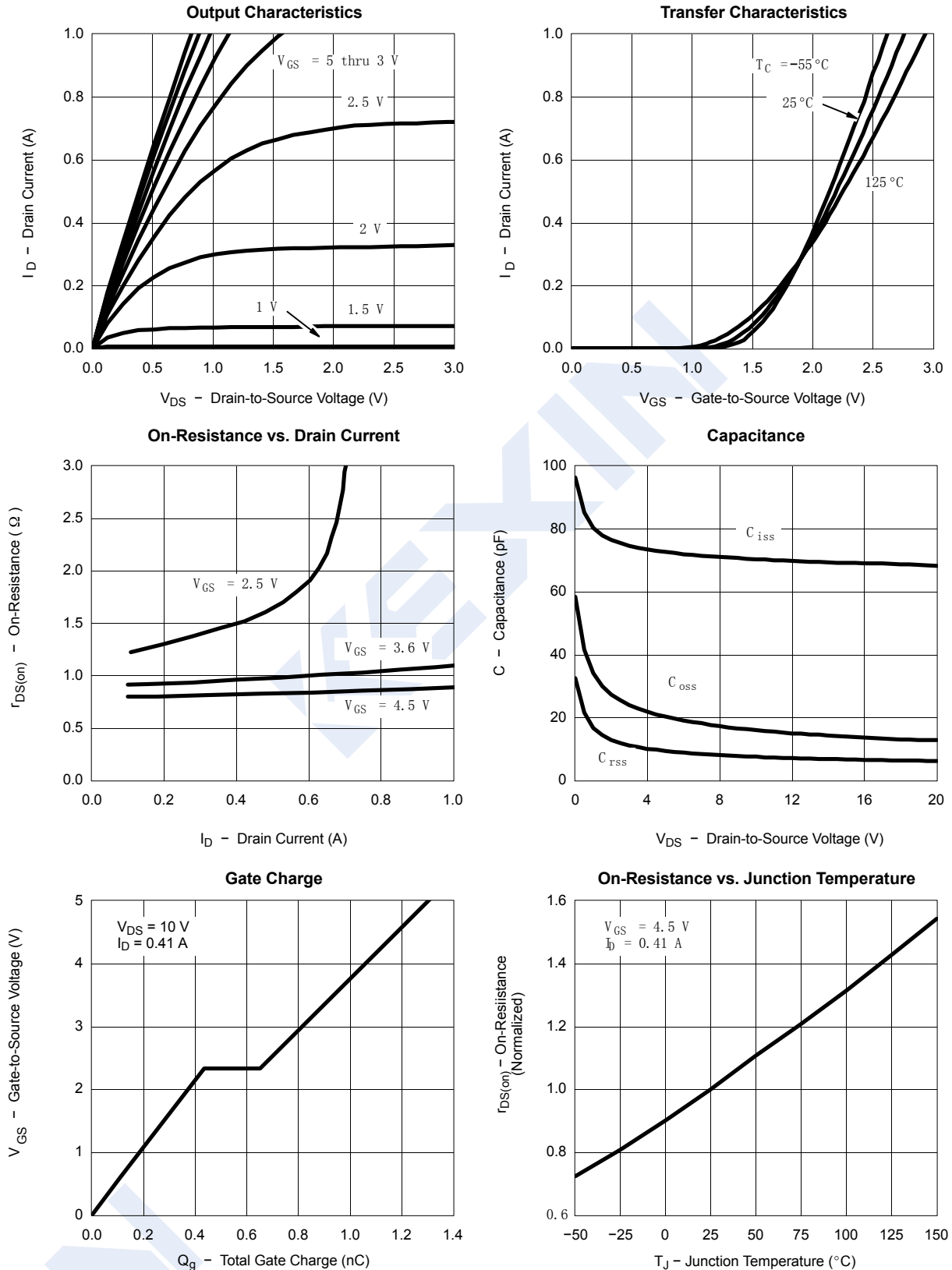

Dual P-Channel MOSFET SI1903DL (KI1903DL)

■ Typical Characteristics

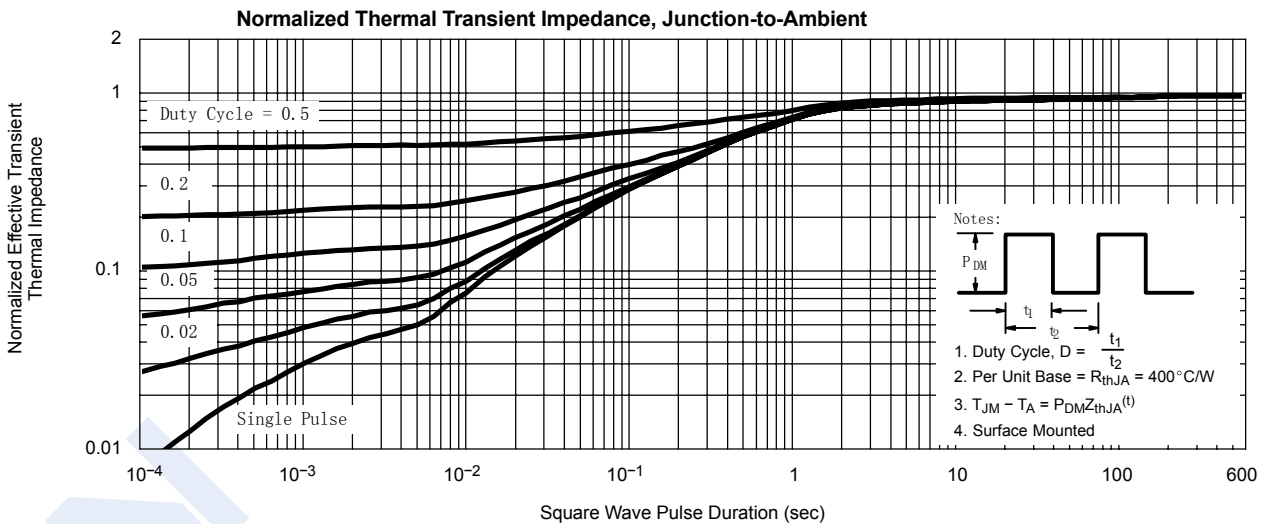
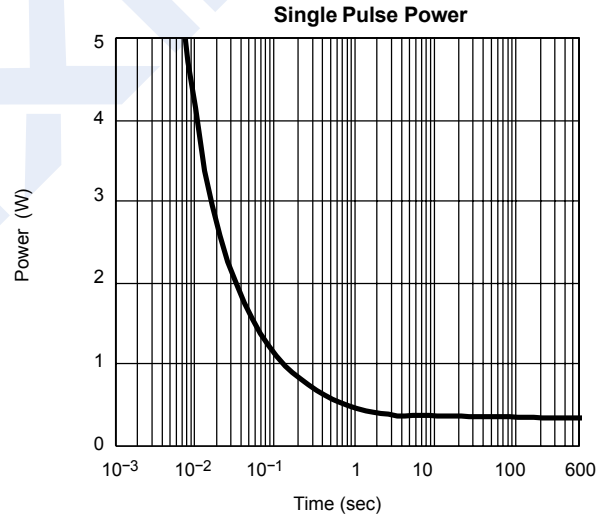
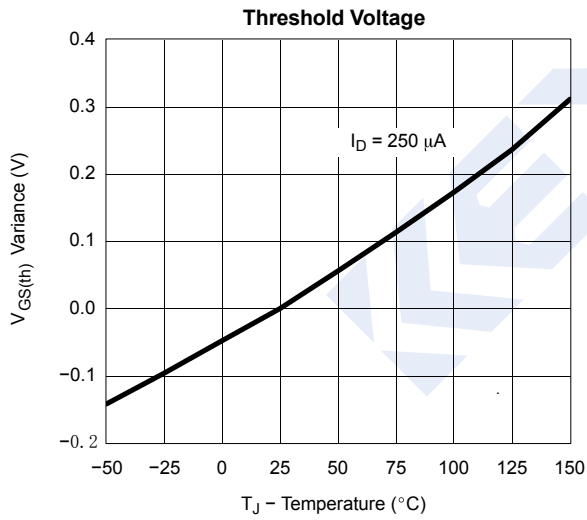
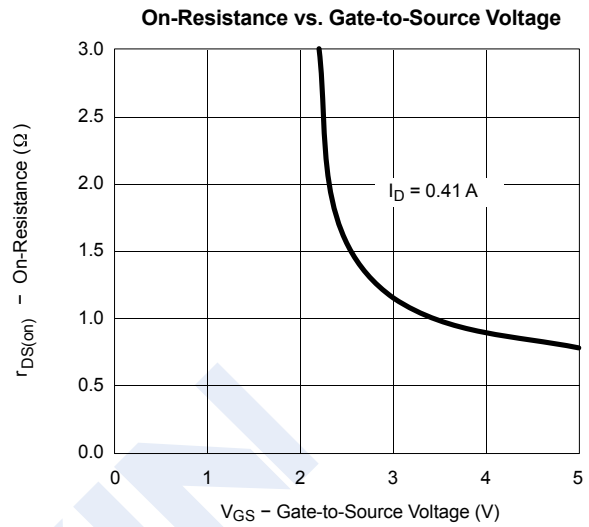
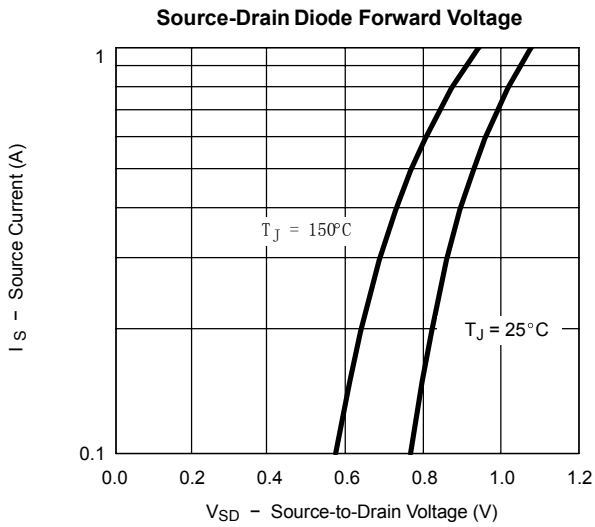

Dual P-Channel MOSFET

SI1903DL (K11903DL)

■ Typical Characteristics

