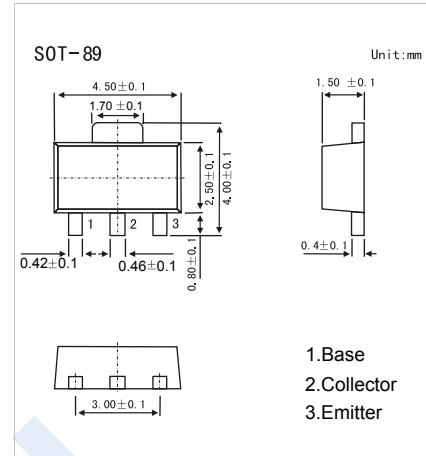

## NPN Transistors

## 2SD1898

## ■ Features

- High  $V_{CE0}$ ,  $V_{CE0}=80V$
- High  $I_c$ ,  $I_c=1A$  (DC)
- Low  $V_{CE(sat)}$
- Complementary to 2SB1260

■ Absolute Maximum Ratings  $T_a = 25^\circ C$ 

Parameter	Symbol	Rating	Unit
Collector - Base Voltage	$V_{CBO}$	120	V
Collector - Emitter Voltage	$V_{CEO}$	80	
Emitter - Base Voltage	$V_{EBO}$	5	
Collector Current - Continuous	$I_c$	1	A
Collector Current - Pulse	$I_{CP}$	2	
Collector Power Dissipation	$P_c$	0.5	W
		2	
Junction Temperature	$T_J$	150	$^\circ C$
Storage Temperature Range	$T_{stg}$	-55 to 150	

■ Electrical Characteristics  $T_a = 25^\circ C$ 

Parameter	Symbol	Test Conditions	Min	Typ	Max	Unit
Collector- base breakdown voltage	$V_{CBO}$	$I_c = 100 \mu A, I_E = 0$	120			V
Collector- emitter breakdown voltage	$V_{CEO}$	$I_c = 1 \text{ mA}, I_B = 0$	80			
Emitter - base breakdown voltage	$V_{EBO}$	$I_E = 100 \mu A, I_c = 0$	5			
Collector-base cut-off current	$I_{CBO}$	$V_{CB} = 100 \text{ V}, I_E = 0$			1	$\mu A$
Emitter cut-off current	$I_{EBO}$	$V_{EB} = 4 \text{ V}, I_c = 0$			0.5	
Collector-emitter saturation voltage	$V_{CE(sat)}$	$I_c = 500 \text{ mA}, I_B = 50 \text{ mA}$		0.15	0.4	V
Base - emitter saturation voltage	$V_{BE(sat)}$	$I_c = 500 \text{ mA}, I_B = 50 \text{ mA}$			1.2	
DC current gain	$h_{FE}$	$V_{CE} = 3 \text{ V}, I_c = 500 \text{ mA}$	120		390	
Collector Output capacitance	$C_{ob}$	$V_{CB} = 10 \text{ V}, I_E = 0, f = 1 \text{ MHz}$		20		$\mu F$
Transition frequency	$f_T$	$V_{CE} = 10 \text{ V}, I_E = -50 \text{ mA}, f = 100 \text{ MHz}$		100		MHz

■ Classification of  $h_{FE}$ 

Type	2SD1898-Q	2SD1898-R
Range	120-270	180-390
Marking	DF Q*	DF R*

## NPN Transistors 2SD1898

■ Typical Characteristics

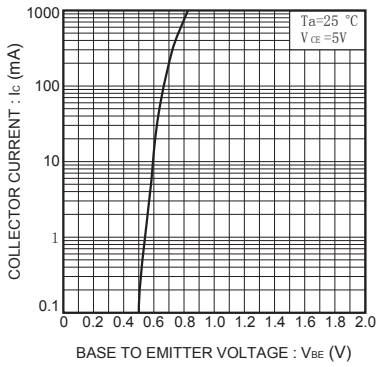

Fig.1 Grounded emitter propagation characteristics

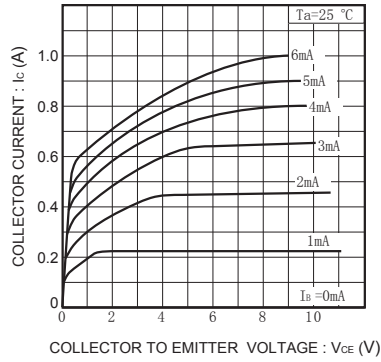

Fig.2 Grounded emitter output characteristics

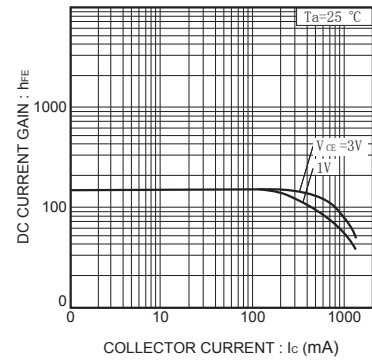

Fig.3 DC current gain vs. collector current

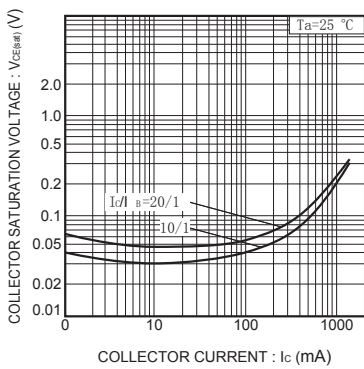

Fig.4 Collector-emitter saturation voltage vs. collector current

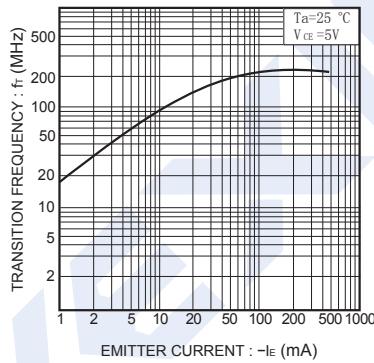

Fig.5 Gain bandwidth product vs. emitter current

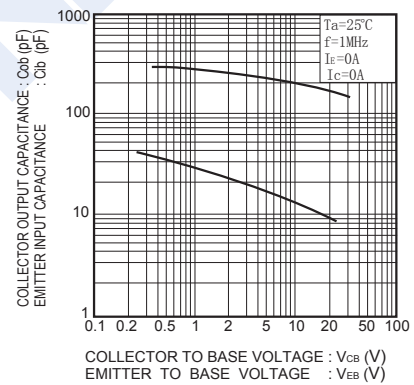

Fig.6 Collector output capacitance vs. collector-base voltage  
Emitter input capacitance vs. emitter-base voltage

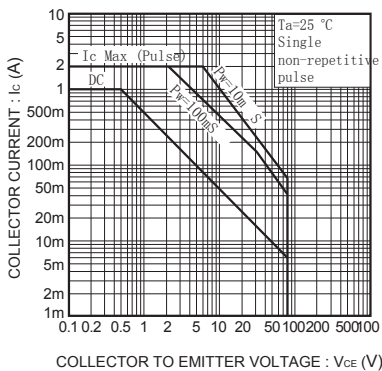

Fig.7 Safe operating area (2SD1898)