

## PNP Transistors

### 2SB935A

#### ■ Features

- Low collector to emitter saturation voltage  $V_{CE(sat)}$
- High-speed switching

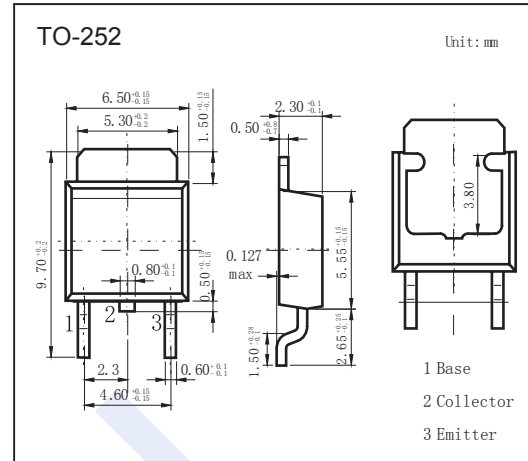

#### ■ Absolute Maximum Ratings $T_a = 25^\circ\text{C}$

Parameter	Symbol	Rating	Unit	
Collector - Base Voltage	$V_{CBO}$	-50	V	
Collector - Emitter Voltage	$V_{CEO}$	-40		
Emitter - Base Voltage	$V_{EBO}$	-5		
Collector Current - Continuous	$I_C$	-10	A	
Collector current - Pulse	$I_{CP}$	-15		
Collector Power Dissipation	$P_C$	$T_c = 25^\circ\text{C}$	35	W
		$T_a = 25^\circ\text{C}$	1.3	
Junction Temperature	$T_J$	150	$^\circ\text{C}$	
Storage Temperature range	$T_{stg}$	-55 to 150		

#### ■ Electrical Characteristics $T_a = 25^\circ\text{C}$

Parameter	Symbol	Test Conditions	Min	Typ	Max	Unit
Collector-base breakdown voltage	$V_{CBO}$	$I_C = -100 \mu\text{A}$ , $I_E = 0$	-50			V
Collector-emitter breakdown voltage	$V_{CEO}$	$I_C = -10 \text{mA}$ , $I_B = 0$	-40			
Emitter - base breakdown voltage	$V_{EBO}$	$I_E = -100 \mu\text{A}$ , $I_C = 0$	-5			
Collector-base cut-off current	$I_{CBO}$	$V_{CB} = -50\text{V}$ , $I_E = 0$			-50	$\mu\text{A}$
Emitter cut-off current	$I_{EBO}$	$V_{EB} = -5\text{V}$ , $I_C = 0$			-50	
Collector-emitter saturation voltage	$V_{CE(sat)}$	$I_C = -7 \text{A}$ , $I_B = -230\text{mA}$			-0.6	V
Base - emitter saturation voltage	$V_{BE(sat)}$	$I_C = -7 \text{A}$ , $I_B = -230\text{mA}$			-1.5	
DC current gain	$h_{FE(1)}$	$V_{CE} = -2\text{V}$ , $I_C = -100\text{mA}$	45			
	$h_{FE(2)}$	$V_{CE} = -2\text{V}$ , $I_C = -2 \text{A}$	90		260	
Turn-on time	$t_{on}$	$I_C = -2 \text{A}$ , $I_{B1} = -66\text{mA}$ , $I_{B2} = 66\text{mA}$		0.1		
Storage time	$t_{stg}$			0.5		
Fall time	$t_f$			0.1		
Collector output capacitance	$C_{ob}$	$V_{CB} = -10\text{V}$ , $I_E = 0$ , $f = 1\text{MHz}$		200		$\mu\text{F}$
Transition frequency	$f_T$	$V_{CE} = -10\text{V}$ , $I_C = -500\text{mA}$ , $f = 10\text{MHz}$		150		MHz

#### ■ Classification of $h_{FE(2)}$

Type	2SB935A-Q	2SB935A-P
Range	90-180	130-260

# PNP Transistors

## 2SB935A

### Typical Characteristics

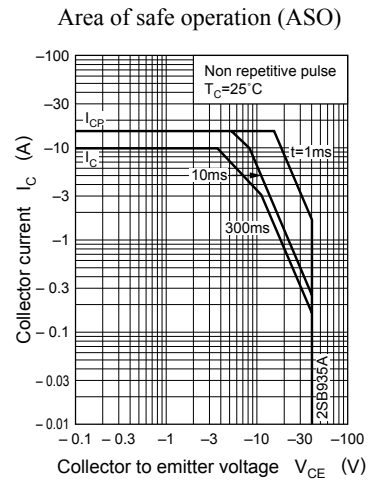
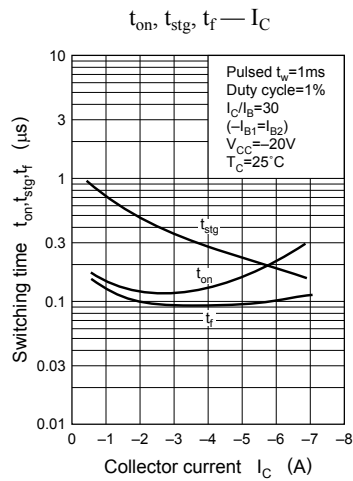
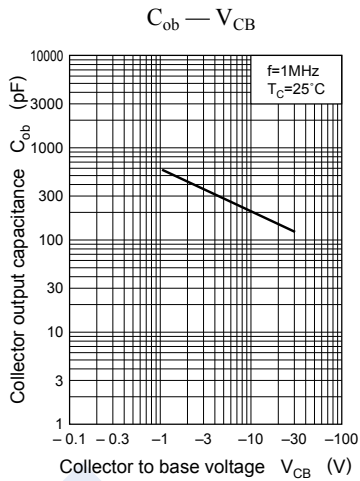
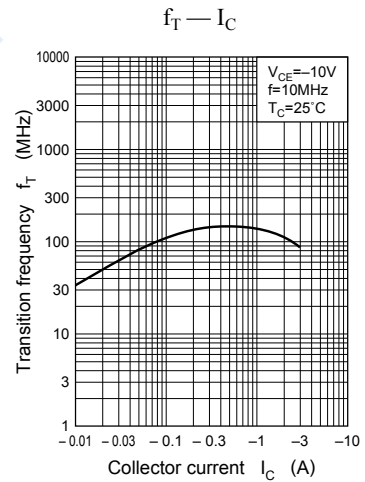
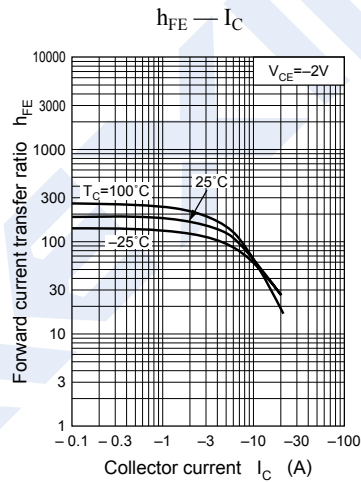
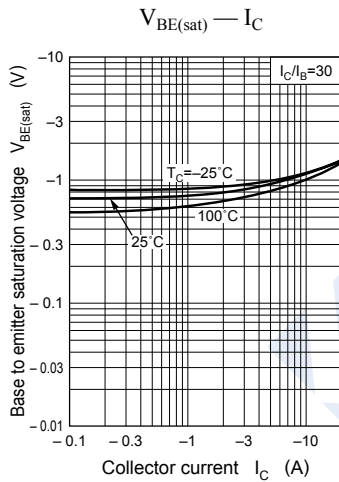
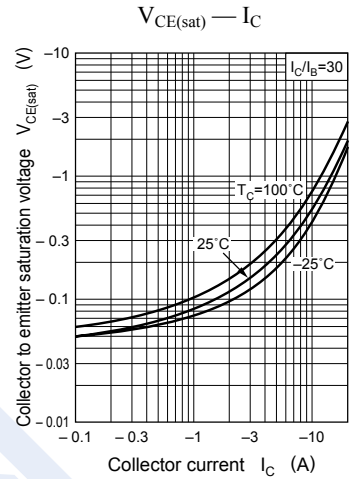
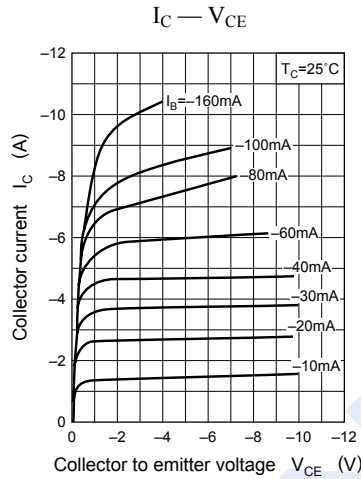
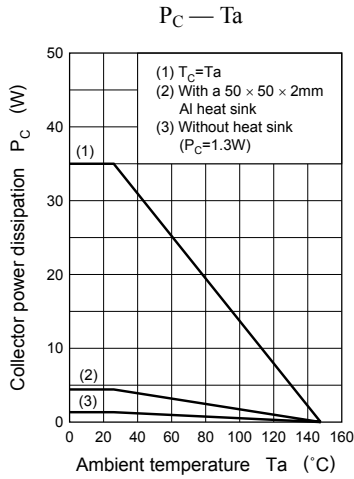

## PNP Transistors

## 2SB935A

## ■ Typical Characteristics

